

Z-orret

Sleeve-jatketut Z-orret

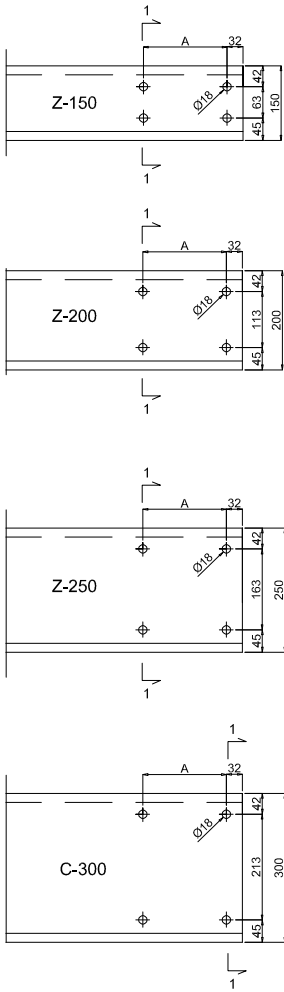

Sleeve-jatkoskappaleet

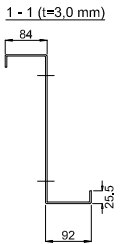
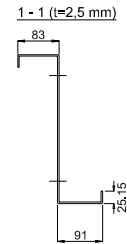
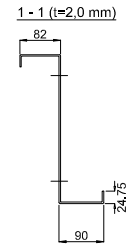
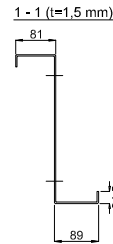
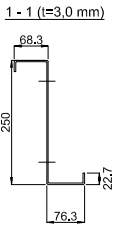
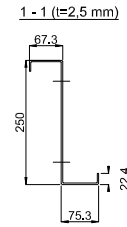
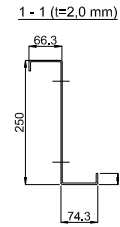
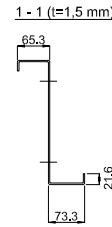
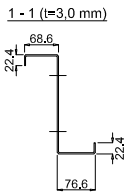
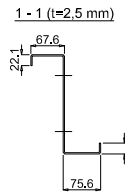
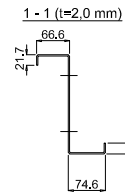
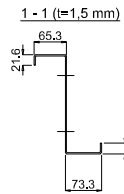
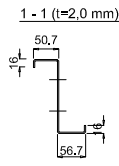
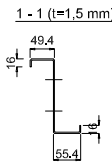
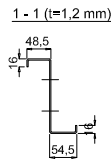
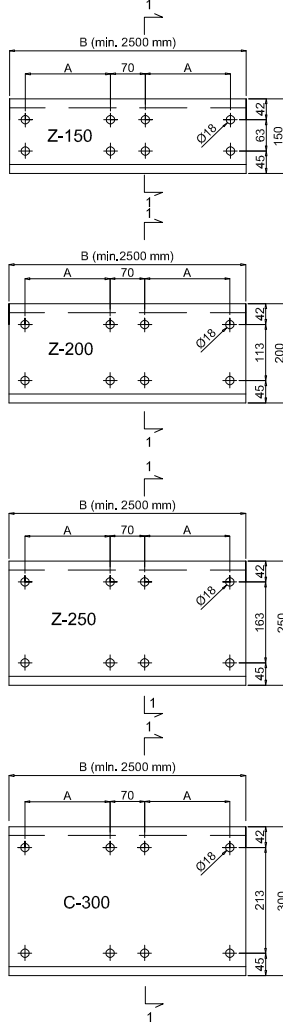

Limitety Z-orret

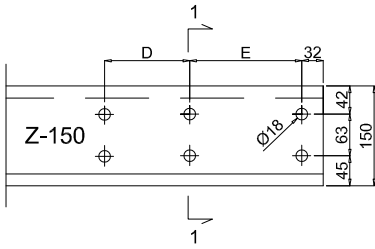

1 - 1 (t=1,2 mm)

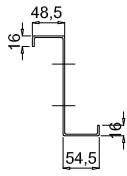

1 - 1 (t=1,5 mm)

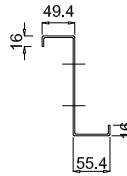

1 - 1 (t=2,0 mm)

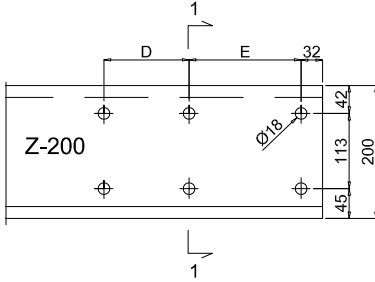
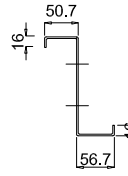

1 - 1 (t=1,5 mm)

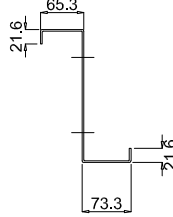

1 - 1 (t=2,0 mm)

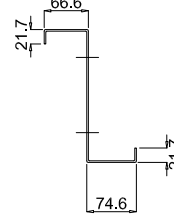

1 - 1 (t=2,5 mm)

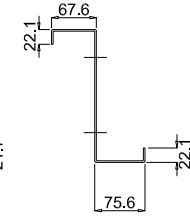

1 - 1 (t=3,0 mm)

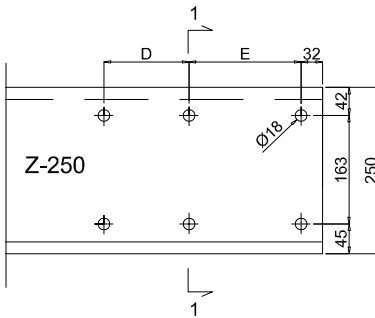
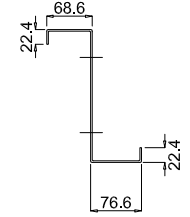

1 - 1 (t=1,5 mm)

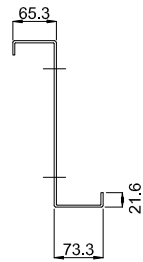

1 - 1 (t=2,0 mm)

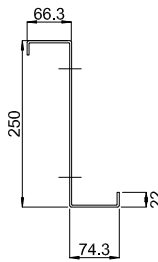

1 - 1 (t=2,5 mm)

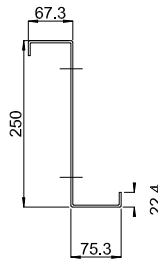

1 - 1 (t=3,0 mm)

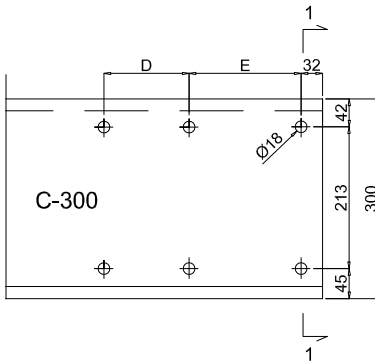
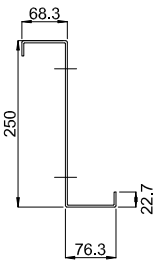

1 - 1 (t=1,5 mm)

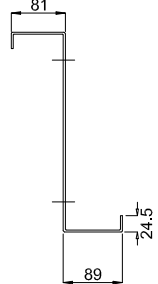

1 - 1 (t=2,0 mm)

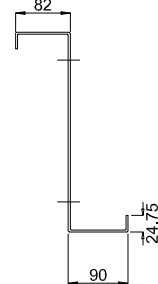

1 - 1 (t=2,5 mm)

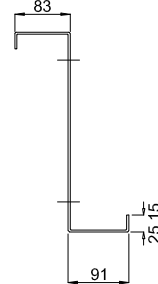

1 - 1 (t=3,0 mm)

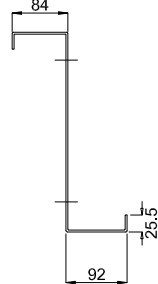

1-aukkoiset Z-orret

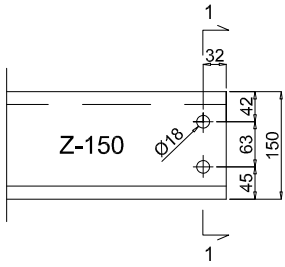

1 - 1 (t=1,2 mm)

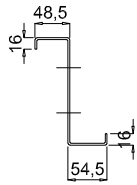

1 - 1 (t=1,5 mm)

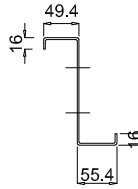

1 - 1 (t=2,0 mm)

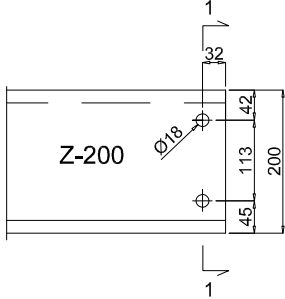
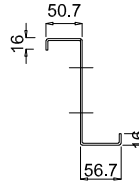

1 - 1 (t=1,5 mm)

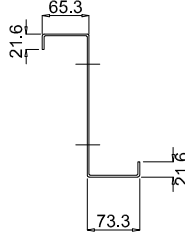

1 - 1 (t=2,0 mm)

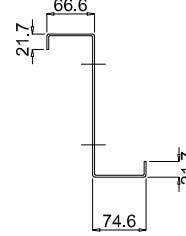

1 - 1 (t=2,5 mm)

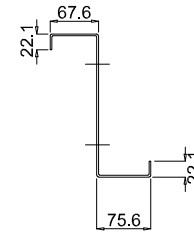

1 - 1 (t=3,0 mm)

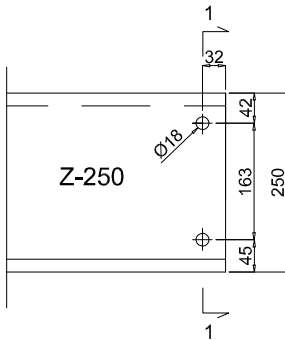
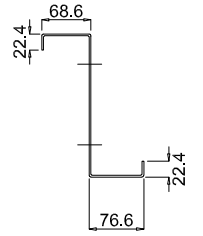

1 - 1 (t=1,5 mm)

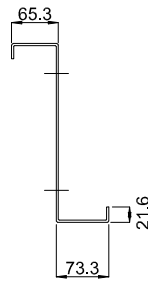

1 - 1 (t=2,0 mm)

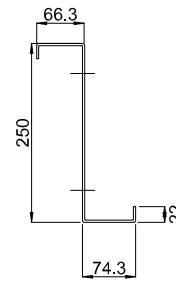

1 - 1 (t=2,5 mm)

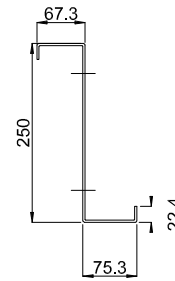

1 - 1 (t=3,0 mm)

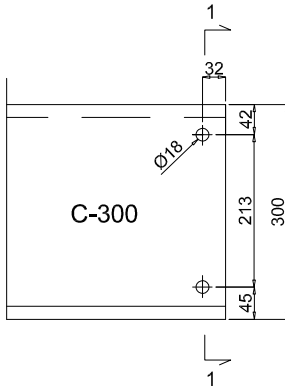
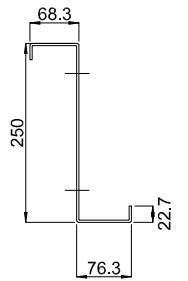

1 - 1 (t=1,5 mm)

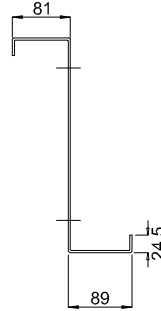

1 - 1 (t=2,0 mm)

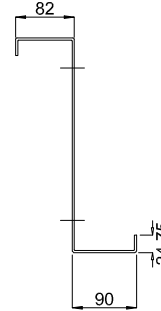

1 - 1 (t=2,5 mm)

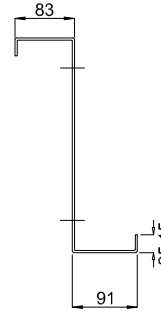

1 - 1 (t=3,0 mm)

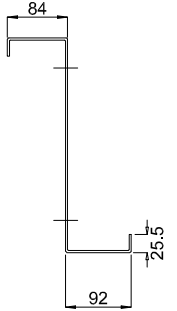

C-orret

1-aukkoiset C-orret

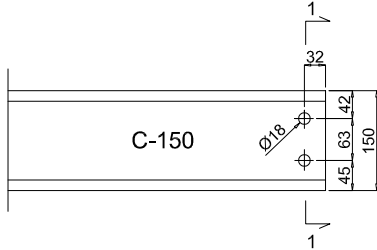

1 - 1 (t=1,2 mm)

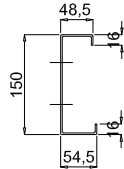

1 - 1 (t=1,5 mm)

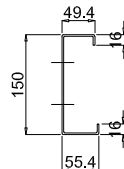

1 - 1 (t=2,0 mm)

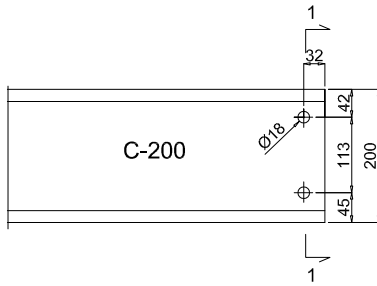
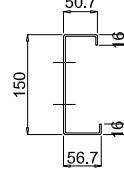

1 - 1 (t=1,5 mm)

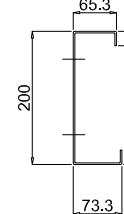

1 - 1 (t=2,0 mm)

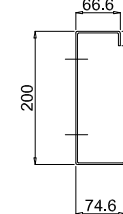

1 - 1 (t=2,5 mm)

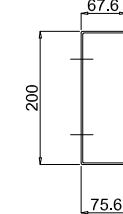

1 - 1 (t=3,0 mm)

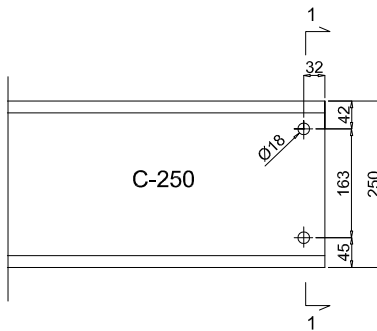
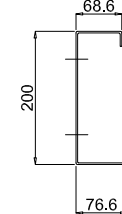

1 - 1 (t=1,5 mm)

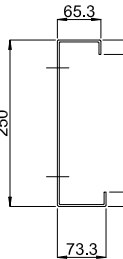

1 - 1 (t=2,0 mm)

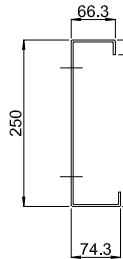

1 - 1 (t=2,5 mm)

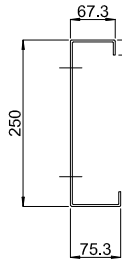

1 - 1 (t=3,0 mm)

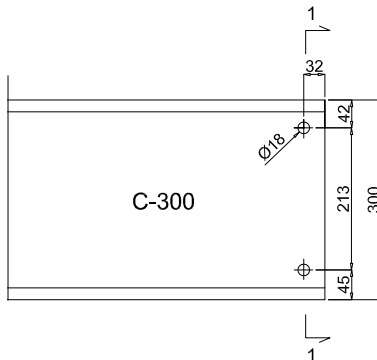
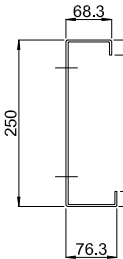

1 - 1 (t=1,5 mm)

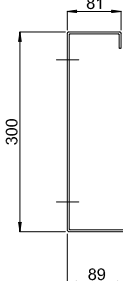

1 - 1 (t=2,0 mm)

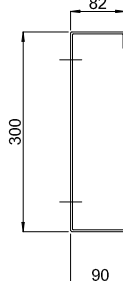

1 - 1 (t=2,5 mm)

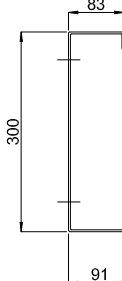

1 - 1 (t=3,0 mm)

